

Technical sheet :

MRT 3060

VISION +



Capacities			Metric	Imperial
Max. capacity			6000 kg	13,200 lb
Max. lifting height			29.90 m	98 ft 1 in
Max. outreach	r1		25.70 m	84 ft 4 in
Weight and dimensions				
Overall width	b1		2.50 m	8 ft 2 in
Overall height	h17		3.10 m	10 ft 2 in
Overall cab width	b4		0.96 m	38 in
Ground clearance	m4		0.36 m	14 in
Wheelbase	y		3.25 m	10 ft 8 in
Tilt-up angle	a4		12 °	12 °
Tilt-down angle	a5		112 °	112 °
Overall weight			21800 kg	48,061 lb
Wheels				
Standard tires			445/65 R22,5	445/65 R22,5
Drive wheels (front / rear)			2 / 2	2 / 2
Steering mode			2 wheel steer, 4 wheel steer, Crab mode	2 wheel steer, 4 wheel steer, Crab mode
Stabilizers				
Stabs Type			Telescopic Duplex	Telescopic Duplex
Controls			Individual or Simultaneous	Individual or Simultaneous
Engine				
Engine brand			Yanmar	Yanmar
Engine nom			Stage V / Tier 4	Stage V / Tier 4
Engine model			4TN107FTT-6SMU1	4TN107FTT-6SMU1
I.C. Engine power rating / Power (kW)			173 Hp / 127 kW	173 Hp / 127 kW
Max. torque / Engine rotation (min)			805 Nm @ 1500 rpm	544 ft-lbs @ 1500 rpm
Number of cylinders - Capacity of cylinders			4 - 4567 cm³	4 - 279 in³
Number of batteries / Battery / Batteries capacity			2 x 12 V / 120 Ah	2 x 12 V / 120 Ah
Battery starting current			(EN)850 A	(EN)850 A
Transmission				
Transmission type			Hydrostatic with Speedshift	Hydrostatic with Speedshift
Gearbox / Number of gears (forward) / Number of gears (reverse)			Speedshift / 2 / 2	Speedshift / 2 / 2
Max. travel speed			40 km/h	25 mph
Parking brake			Automatic negative parking brake	Automatic negative parking brake
Service brake			Oil-immersed multi-discs braking on front & rear axles	Oil-immersed multi-discs braking on front & rear axles
Hydraulics				
Hydraulic pump type			Load sensing pump	Load sensing pump
Hydraulic flow			185 l/min	49 gal/min
Hydraulic Pressure			350 Bar	5076 PSI
Tank capacities				
Engine oil			13 l	3 US gal
Hydraulic oil			300 l	79 US gal
Fuel tank			320 l	85 US gal
Diesel Exhaust fluid (AdBlue® type)			24 l	6 US gal
Miscellaneous				
Steering wheels (front / rear)			2 / 2	2 / 2
Controls			2 Joysticks	2 Joysticks
Safety cab homologation			ROPS - FOPS cab (level 2)	ROPS - FOPS cab (level 2)
Attachment recognition system (E-Reco)			Standard	Standard

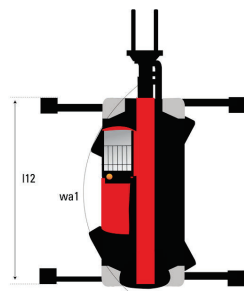
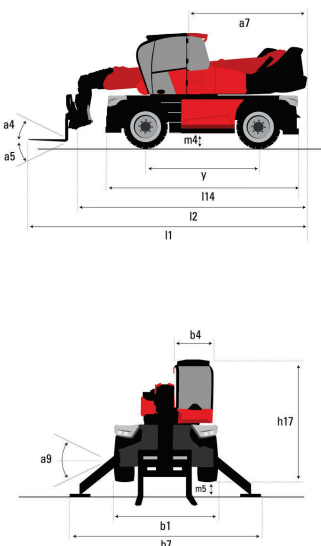

MRT 3060 - Dimensional drawing

Other data		Imperial	Metric
Overall length (with forks)	I1	30 ft	9.14 m
Length to face of forks	I2	26 ft 1 in	7.94 m
Length of frame	I14	19 ft 5 in	5.92 m
Wheelbase	y	10 ft 8 in	3.25 m
Ground clearance	m4	14 in	0.36 m
Counterweight offset (turret at 90°)	a7	11 ft 4 in	3.45 m
Tilt-up angle	a4	12 °	12 °
Tilt-down angle	a5	112 °	112 °
Overall length at stabilizers	I12	18 ft 5 in	5.62 m
External turning radius (over tires)	Wa1	14 ft 4 in	4.37 m
Overall width	b1	8 ft 2 in	2.50 m
Overall width with stabilizers extended	b7	19 ft 11 in	6.06 m
Overall cab width	b4	38 in	0.96 m
Overall height	h17	10 ft 2 in	3.10 m
Frame leveling corrector	a9	+/- 7 °	+/- 7 °
Ground clearance under front tires on stabilizers	m5	1 ft 6 in	0.45 m

Machine on tires with forks

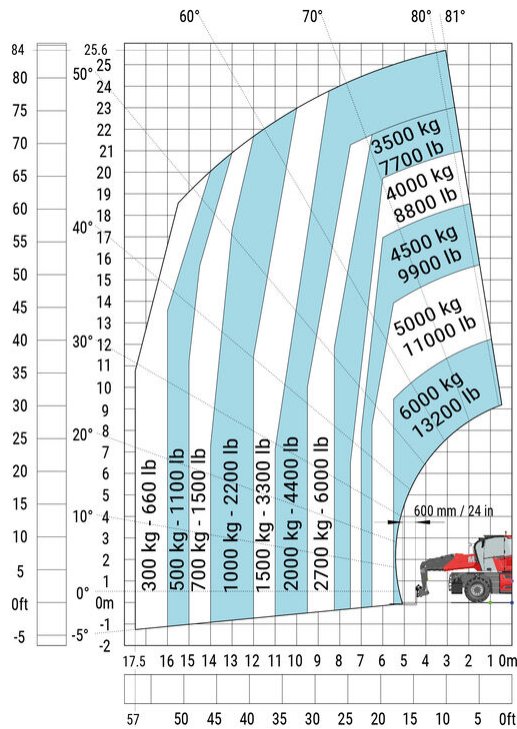

Machine on lowered stabilizers with forks

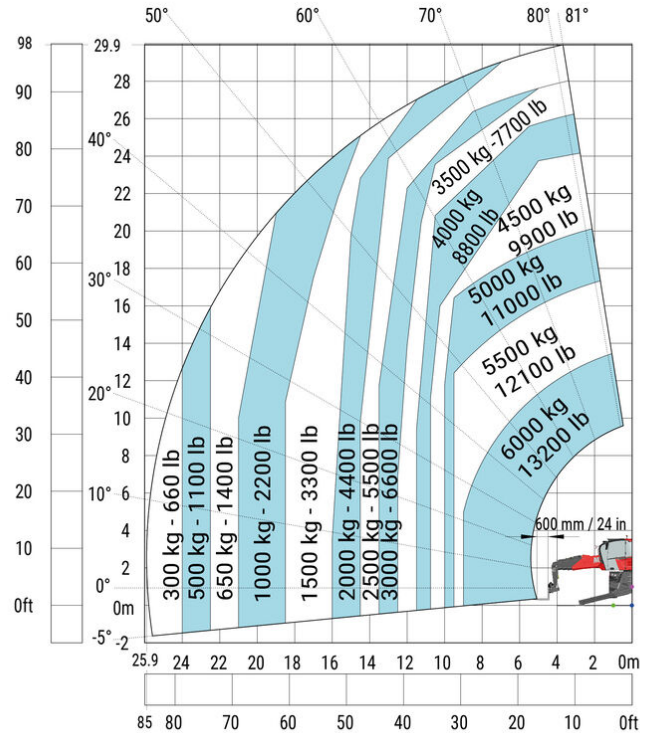

Machine on lowered stabilizers with winch 13,200 lb

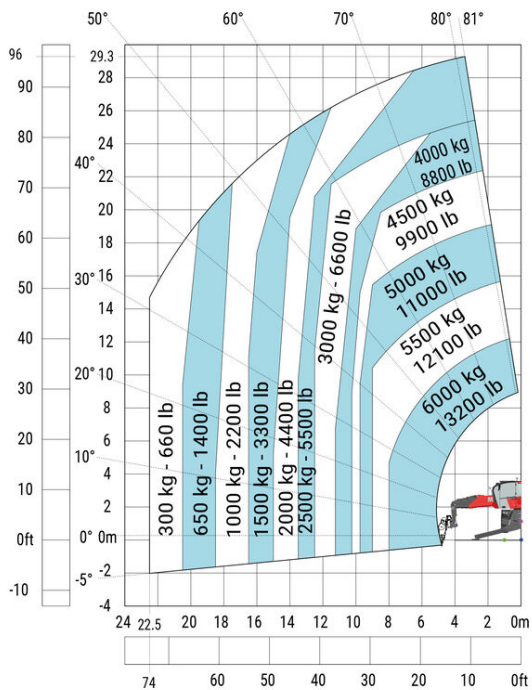

Machine on lowered stabilizers with 2,200 lb platform

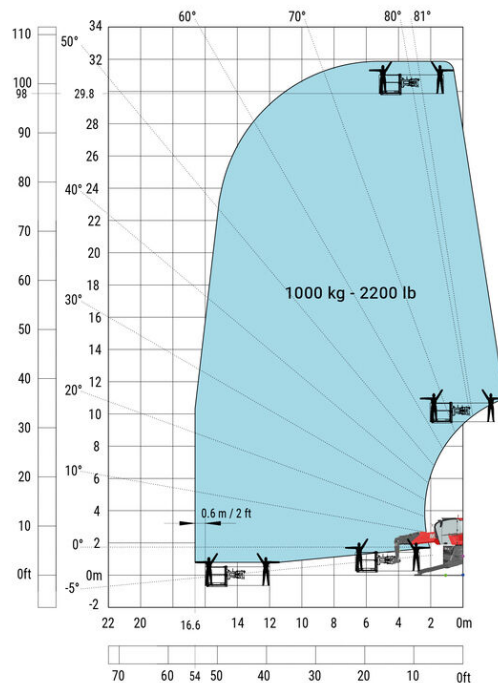

Machine on lowered stabilizers with hook 13,200 lb

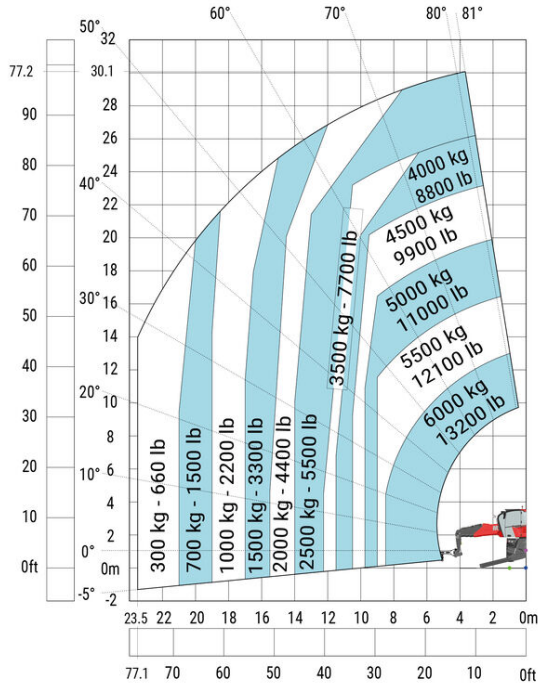

Machine on lowered stabilizers with 4,400 lb jib

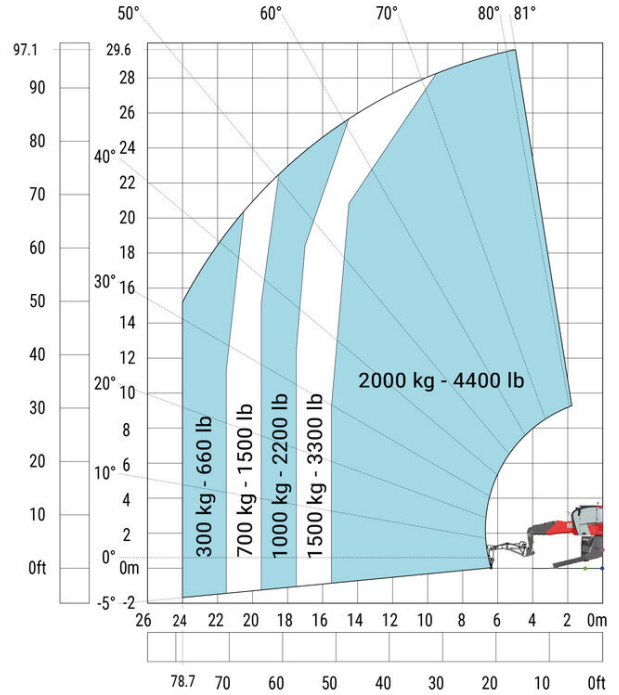

Manitou North America, LLC
 P.O. Box 179 - West Bend, WI 53095
 Tel: 262-334-9461 www.manitou.com



This brochure describes versions and configuration options for Manitou products which may be fitted with different equipment. The equipment described in this brochure may be standard, optional or not available depending on version. Manitou reserves the right to change the specifications shown and described at any time and without prior warning. The manufacturer is not liable for the specifications given. For more information, contact your Manitou dealer. Non-contractual document. Product descriptions may differ from actual products. List of specifications is not comprehensive. The logos and visual identity of the company are the property of Manitou and may not be used without authorisation. All rights reserved. The photos and diagrams contained in this brochure are provided for information only.

MANITOU BF SA - Limited company with board of directors - Share capital: 39,668,399 euros - 857 802 508 RCS Nantes